



**Model CW5**  
**OPERATING MANUAL**  
Manual No. 513801



*Dear customer,*  
*we congratulate you for choosing a high quality product  
 which will surely satisfy your expectations.*

*With our thanks for choosing us, we kindly invite you  
 to examine the present operating instructions manual  
 before operating your new machine.*

## SUMMARY

<p><b>1 IMPORTANT SAFETY SUGGESTIONS AND PRECAUTIONS ..... 4</b></p> <p><b>2 TECHNICAL DATA ..... 5</b></p> <p style="padding-left: 20px;">2.1 Technical data plate and CE marking ..... 5</p> <p style="padding-left: 20px;">2.2 Acoustic pressure level ..... 5</p> <p><b>3 CARRYING AND UNPACKING ..... 5</b></p> <p><b>4 INSTALLATION ..... 5</b></p> <p style="padding-left: 20px;">4.1 Placing ..... 6</p> <p style="padding-left: 20px;">4.2 Assembling ..... 6</p> <p style="padding-left: 20px;">4.3 Electrical connection ..... 6</p> <p><b>5 MACHINE'S OPERATION ..... 7</b></p> <p style="padding-left: 20px;">5.1 Controls and indicators ..... 7</p>	<p>5.2 Operating the machine ..... 8</p> <p>5.3 Setting of air-inlet valve ..... 9</p> <p>5.4 Using the TIMER function ..... 9</p> <p>5.5 Tub defrosting ..... 9</p> <p><b>6 WASHING AND SANITISING ..... 9</b></p> <p style="padding-left: 20px;">6.1 Warnings and hints ..... 9</p> <p style="padding-left: 20px;">6.2 Washing procedure ..... 10</p> <p><b>7 MAINTENANCE ..... 11</b></p> <p style="padding-left: 20px;">7.1 Checking gaskets ..... 11</p> <p style="padding-left: 20px;">7.2 Yearly maintenance ..... 11</p> <p style="padding-left: 20px;">7.3 Warnings for the service engineer ..... 11</p> <p><b>8 PERIODS OF INACTIVITY ..... 12</b></p> <p><b>9 MALFUNCTIONS ..... 12</b></p>
--	---

### WARNING:



**GENERAL/MECHANICAL  
DANGER**



**DANGEROUS  
VOLTAGE**

**A TEXT IN CAPITOL LETTERS, IDENTIFIED BY ONE OF THE SYMBOLS ABOVE, CONTAINS INSTRUCTIONS THAT, IF NOT FOLLOWED, MAY CAUSE HARM TO PEOPLE.**



**A text in lower-case, identified by this symbol, contains instructions that, if not followed, could cause damages or malfunctions to the device, or falls in its quality.**

# 1 IMPORTANT SAFETY SUGGESTIONS AND PRECAUTIONS



**PLEASE READ THESE INSTRUCTIONS BEFORE ATTEMPTING TO INSTALL AND OPERATE YOUR MACHINE.**



**THIS MANUAL PROVIDES ALL INFORMATION REQUIRED TO INSTALL, OPERATE AND MAINTAIN MACHINE UNDER SAFE CONDITIONS. FAILURE TO COMPLY WITH THE SAFETY MEASURES SET OUT IN THIS HANDBOOK MAY RESULT IN SERIOUS DAMAGE TO THE MACHINE AS WELL AS FORFEIT ANY MANUFACTURER'S GUARANTEE.**

- All technical documentation supplied with the CREAM-WHIPPER (from now on defined as “MACHINE”) is to be considered as an INTEGRAL PART of the machine and kept in a safe place for as long as the machine is in existence. This documentation, in compliance with the law in force (EU directives on health and safety measures), is made up by:
  - OPERATING INSTRUCTIONS (this manual): it must be read by the USER as well as anyone authorized to INSTALL it. It provides all information required to correctly install the machine, correctly operate it, for routine maintenance and any possible malfunction of the machine;
  - TECHNICAL HANDBOOK: it contains the machine's technical specifications (characteristics, diagrams, spare parts etc.) It is to be referred to by the AUTHORIZED ASSISTANCE SERVICE personnel to whom any call for assistance must be given.
  - EU DECLARATION OF COMPLIANCE: in compliance with EU directives relevant to the machine;
  - FORM of electric running tests.
- In case of sale or transfer of the machine to another person, the above documentation must be handed over to the new owner in order to become acquainted with all safety norms, technical specifications as well as how to operate the machine.
- Always unplug the machine before proceeding with any maintenance, that will have to be performed by professionally qualified and certified personnel.
- Any modifying of the electrical supply plant must be exclusively performed by professionally qualified and certified personnel.
- Any use of the machine that is not for the production of whipped cream, ice-cream cake or mousse, is to be considered improper.
- Do not connect and/or operate the machine when any part is missing.
- Do not introduce objects, tools or other in the machine's loopholes.
- The machine is designed to be operated by adults: do not allow children to get close and untrained people to operate it.
- Modifying, or attempting to modify this machine, can be dangerous and would void any type of warranty.
- Always use original spare parts.
- As soon as the user discontinues operation of the machine, we recommend to rendering it inoperative by cutting its supply cable (after having unplugged the machine). We also recommend to:
  - avoid dispersing the freezing gas and the oil contained in the condenser;
  - carry out the draining and/or recycling according to the local provisions of the law currently in force on this matter.

## 2 TECHNICAL DATA

### 2.1 Technical data plate and CE marking

The technical data plate and CE marking must not be removed. It is located on the back part of the machine and identifies:

- the name and address of the manufacturer [F];
- the designation of the model [MOD.] and the relative series number [S/N];
- the type [GAS] and quantity [gr] of freezing gas contained;
- the year of construction [ANNO];
- voltage [V], frequency [Hz] and number of phases [Ph], electrical input power [kW] and current [A];
- the CE marking.

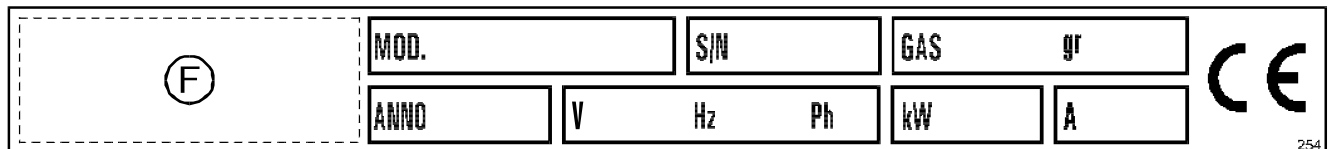

### 2.2 Acoustic pressure level

The average equivalent continuous acoustic pressure level of this machine is lower than 70 dB(A). This data has been measured at 1 meter from the surface of the machine and at 1.60 meters from ground-level, during the machine's functioning.

## 3 CARRYING AND UNPACKING

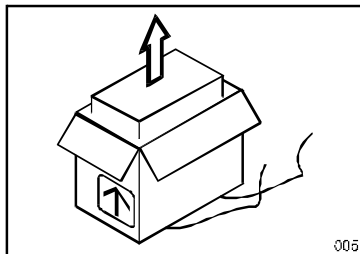

The weight of this machine, net and with packing, are stated both in the packing list and on the packing itself.



**To prevent the oil contained in the compressor to flow into the refrigerating circuit, it is necessary to always keep the machine in upright position, both during carrying and during the installation and operation. Always follow the instructions on the packing.**

To unpack the machine, cut the strings, open up the pack from the top, pull away the protecting cardboards and pull out the machine.

After unpacking the machine, make sure it has not visible damage. In case of doubt, don't use it and ask for help directly from your dealer.

*Note:* The packing is made out of recyclable materials (cardboard).

## 4 INSTALLATION



**THE INSTALLATION MUST BE MADE IN COMPLIANCE WITH THE LAWS IN FORCE, ALWAYS FOLLOWING INSTRUCTIONS OF THE MANUFACTURER.**

## 4.1 Placing

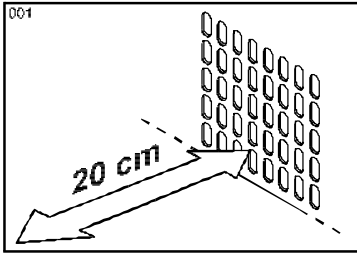

Place the machine on a flat and steady surface.

Install the machine away from any source of heat, avoiding direct exposure to sun radiation and making sure that air can freely circulate around each side of the machine itself. In particular, the free space in front of the grid of the condenser must be of at least 20 cm or more.

Make sure that the pump body [3] is complete with the air-inlet valve [11] and the suction tube [15], then check that the packing contains:

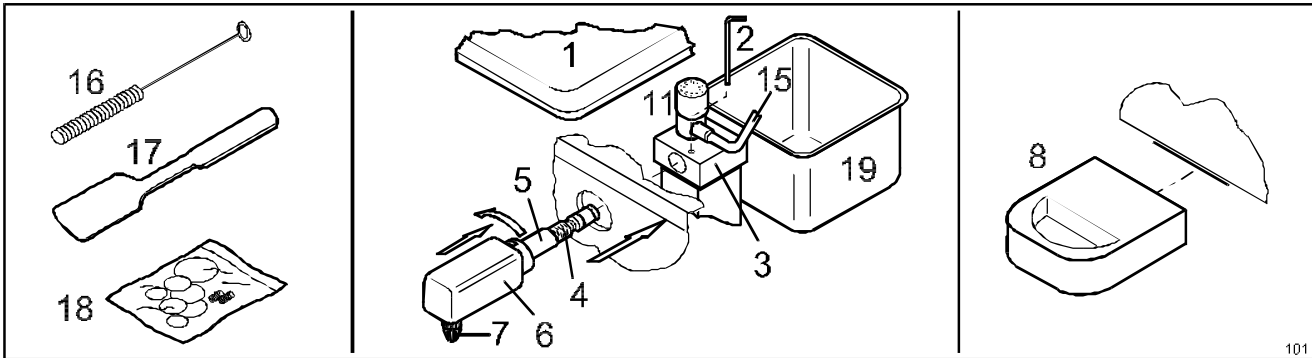

- complete supply faucet [6], labyrinth-tube [5] and labyrinth [4];
- container [19];
- drip tray [8];
- tube-brush [16] and plastic blade [17];
- spare parts outfit bag [18].

Also make sure that the Technical Handbook, the EC Conformity Certification and Electrical Tests Schedule are included.

## 4.2 Assembling

Proceed with the installation of the parts as follows:

- remove the lid [1] and fastening shaft [2];
- insert the labyrinth [4] with the labyrinth-tube [5] into the pump [3] through the hole on front panel;
- install the fastening shaft [2], that will be inserted itself into the labyrinth [4] groove;
- insert the faucet [6] into the hole on the front panel correctly placed with the outlet nozzle [7] turned downwards, rotating it counterclockwise;
- install drip tray [8] in the appropriate slot in the front panel.

## 4.3 Electrical connection

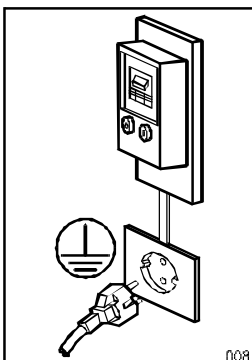

**THE ELECTRICAL SAFETY OF THIS MACHINE IS REACHED ONLY WHEN THE SAME IS CORRECTLY CONNECTED, BY QUALIFIED AND CERTIFIED PERSONNEL, TO AN ELECTRICAL PLANT PROVIDED WITH AN EFFICIENT EARTHING SYSTEM, MADE AS REQUIRED BY IN FORCE SAFETY REGULATIONS.**



**MAKE SURE THAT THE VOLTAGE PRESENT IN THE ELECTRICAL NETWORK IS SUITABLE WITH THE VOLTAGE REQUESTED BY THE MACHINE (GIVEN ON THE TECHNICAL DATA PLATE OR IN THE TECHNICAL HANDBOOK).**

**The manufacturer shall not be responsible for any damages caused by a faulty electrical supply or earthing plant.**

Check that the electrical capacity of the plant is adequate to the maximum requirements of the machine as indicated in the technical data plate. Make sure that the cable section of the plant is sufficient for the power required by the machine.

It is required, for a safe and correct installation of the machine, to arrange a suitable socket controlled by a power breaker provided for in current safety regulations, with an associated differential safety breaker, positioned so to be easily reached by the operator.

The socket must also be protected by fuses with sizes and capacity adequate to the power required by the machine, indicated on the technical data plate or on the Technical Handbook.

Verify that the plant complies with the above said characteristics and insert the plug in the socket. Only the green POWER  indicator must turn on.

## 5 MACHINE'S OPERATION



**OPERATING THE MACHINE, AS ANY OTHER ELECTRICAL DEVICE, ENTAILS OBSERVING SOME VERY IMPORTANT SAFETY RULES, IN PARTICULAR:**

- Do not touch it with wet or damp feet or hands.
- Do not operate when barefoot.
- Do not pull electrical feeding cable to unplug.
- Do not expose machine to rain and prevent any water from entering, i.e. during washing.
- In case of failure and/or malfunction and any time there is apparent damage to the power supply cable, cut power off and call Assistance Service.



**ALWAYS FOLLOW SAFETY MEASURES (REF. CHAPTER 1).**

### 5.1 Controls and indicators



**ON-OFF Pushbutton  
POWER Indicator**

- By pressing it, the machine is activated: the refrigerator is activated and the supply pump is ready to be activated. The Display shows the preservation temperature inside the refrigeration tank.



**Do not operate ON-OFF  Pushbutton repeatedly. Should you need to turn machine on after switching off, always wait a few minutes in order to prevent overloading compressor.**

*Note: Generally, in case of overload, the compressor automatically switches off. When this happens, the refrigerating system DOES NOT FREEZE, even if a buzzing sound (coming from the FAN) causes the refrigerating system to sound as if it is working.*



**TIMER Pushbutton and Indicator**

- When pressing this pushbutton (indicator light will blink), the TIMER function for the whipped cream supply pump is activated. During the procedure, the Display shows the preset dispensing time. For more details on its use, refer to Par. 5.4 - Using the TIMER function.
- When pressing this pushbutton again, indicator light goes out and the timed functioning is deactivated: dispensing will take place for as long as DISPENSING  is manually pressed. The Display shows the preservation temperature again.





**“+” and “-” Pushbuttons**

- When pressing either, when TIMER  indicator is blinking, the automatic dispensing time can be adjusted. For more details on their use, refer to Par. 5.4 - Using the TIMER function.





### DISPENSING Pushbutton

- When pressing this ushbutton, cream is dispensed:
  - If TIMER  is not active, dispensing will last far as long as pushbutton is manually pressed:
  - If TIMER  is active, dispensing will last for the preset time (see Par. 5.4 - Using the TIMER function).

*Note:* The machine must not operate continually for more than 5 minutes. Prolonged functioning may cause the automatic stopping of the pump. The machine may resume the dispensing of cream only after the cooling of the motor, after approx. 15-20 minutes.



### Digital DISPLAY

- When switched on, and whenever the TIMER  indicator is off, the Display shows the preservation temperature (inside refrigeration tank) in °C.
- When TIMER  indicator blinks, the Display shows the preset dispensing time.

## 5.2 Operating the machine

- 1) Press ON-OFF  Pushbutton to turn the machine on:

*Note:* The Display shows the temperature inside the refrigeration tank (in °C). Wait until the temperature inside the tank has dropped (~+4°C), before filling machine with liquid cream.



**Never push the DISPENSING  Pushbutton before pouring any liquids in the container. The pump must not operate dry, otherwise it may be damaged.**

- 2) Before starting the production of whipped cream, wash, rinse and sanitize the machine with the appropriate detergents (see Section 6).

*Note:* Lean cream will not whip, while fat cream tends to make into butter.

*The more the cream is sugared, the less it whips. Avoid adding any sugar for more than 5%. We recommend using liquid sugar.*

*Liquid cream ideal temperature is between +2° and +4° C. Higher temperatures do not assure conservation of cream, and prevent it from whipping. Cooler temperatures separate cream's fats or make it freeze. The machine has been setup during its testing to maintain a temperature suitable to all main kinds of cream.*

**Long preservation cream will have to be stirred and amalgamated, since it tends to make lumps and fats.**

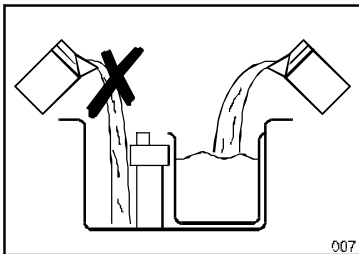

- 3) Pour in the container the best cool cream only in proper quantity. Always use cream in excellent state of preservation;

*Note:* After long periods of inoperation, cream tends to separate. It is then suggested to stir it in the container to make it homogenous.



**Always pour cream in the container, never directly in the refrigeration tub.**

- 4) Setup properly the air-inlet valve (see paragraph 5.3) to obtain the desired increase of volume;
- 5) Should you require the TIMER function, activate it and adjust dispensing time (see Par. 5.4 - Using the TIMER function);
- 6) Dispense cream by pushing DISPENSING  Pushbutton.



## 5.3 Setting of air-inlet valve

Rotating the graduated hand-grip clockwise in the “0” position, the valve will be completely closed. Rotating it **counter-clockwise** the valve will gradually open.

With normal and cool creams, the usual position is between 2 and 5.

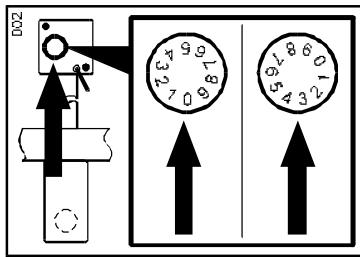

**Note:** When **air is missing**, the dispensed cream will be **wet and flabby**; when instead there is **too much air**, squirts will come out from the nozzle. If air is definitely **excessive**, cream could **make into butter**.

In the same way, with some particular creams, **churning** even when **the cream in the container runs out** and the cream-whipper sucks up only air.

Churned cream obstructs the labyrinth and blocks the whole machine. In this case rotate the graduated hand-grip on position “0”, dispense through the command until you obtain liquid cream and re-setup the air-inlet valve on the proper position.

If satisfying results aren't obtained in this way, it is necessary to disassemble the labyrinth and labyrinth-tube as described in Section 6.

## 5.4 Using the TIMER function

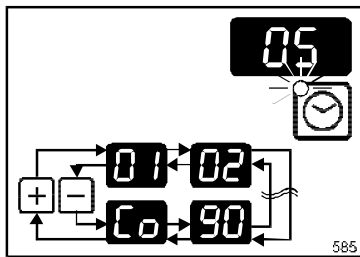

With TIMER, whipped-cream portions can be measured and dispensed by electronically timing the pump's operation.

- Press TIMER and check that indicator light is blinking. The Display will show dispensing time.
- Press “+” or “-” to adjust dispensing time and read setting on Display. Setting can be selected between [Co, 01...90, Co, 01...90] and so forth. If **Co** is selected and DISPENSING Pushbutton is pressed, the pump will operate uninterrupted until DISPENSING Pushbutton is pressed again: this setting is particularly useful during washing.

**Note:** Setting can be done rapidly, by keeping pressed “+” or “-” for a few seconds.

- To deactivate the TIMER function, press TIMER Pushbutton again.

## 5.5 Tub defrosting

As in any other indirect static refrigerating plant, the evaporator (the refrigerating tub) collects the atmospheric humidity and freezes it. To avoid excessive ice formation on the walls of the tub, it is suggested to defrost the tub periodically (2 or 3 times per week), by turning off the machine by means the ON-OFF Pushbutton.

Rotate the suction tube [15] upwards (or pull it away from the air regulator), remove the container [19] and store in a refrigerator the eventually remaining cream. Let the tub defrost at room temperature, and, before turning the machine on, get rid of water by using a sponge. Dry up the surfaces of the tub by using a clean cloth.



Do not scrape the frost away by using sharp tools.

# 6 WASHING AND SANITISING

## 6.1 Warnings and hints



**BACTERIA PROLIFERATE QUICKLY IN FOOD FATS. IT IS THEREFORE NECESSARY TO WASH AND SANITISE THE MACHINE DAILY.**

To wash use anti-foam FOOD COMPATIBLE detergents, carefully following washing instructions.

When washing and sanitising, the pump can be continuously operated by setting TIMER on **Co**. This must be done only as long as there is detergent in the container. To avoid damages to the pump, do not operate it in dry conditions.

## 6.2 Washing procedure

### 1) Washing parts which are in contact with cream (suction pipe, pump, labyrinth / labyrinth-tube and faucet):

- remove any left-over cream and store it in a refrigerator;
- dilute detergent with approximately 1 litre of warm water and pour in the container;
- operate machine until container is empty;
- repeat operation with fresh water to wash off all residues of detergent from machine and container;

### 2) Disassembling and cleaning air regulator:



Omitting to clean the regulator is the main cause of the machine's malfunction.

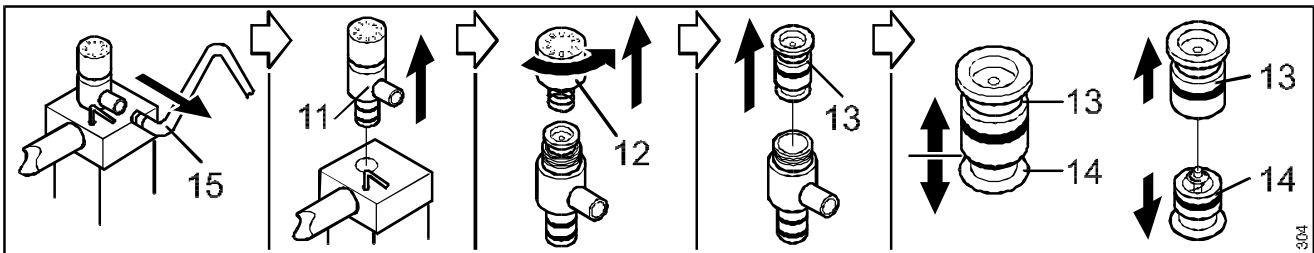

- remove suction pipe [15] and take out regulator's body [11];
- unscrew knob [12] counterclockwise;
- take out valve socket [13] and remove valve [14];
- to make sure suction pipe is not blocked, run water through it;
- wash all parts thoroughly to remove any cream residue;
- assemble and fit air regulator back in its position. All parts have been designed to avoid any error when reassembling.

### 3) Dismantling and washing faucet, labyrinth-tube and labyrinth:

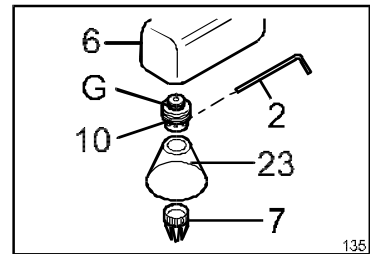
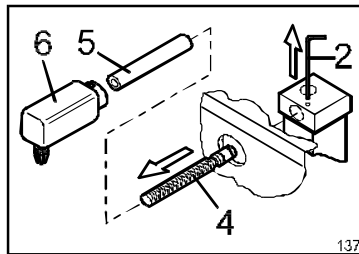
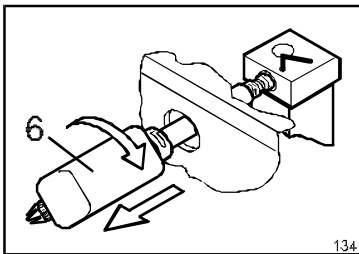

- turn faucet [6] 45 degrees to the right and remove;
- remove fixing rod [2];
- remove labyrinth-tube [5] and labyrinth [4];
- turn nozzle [7] clockwise (if fitted, remove plastic fender [23] too) and remove cream dispenser [10] using, if necessary, fixing rod [2]. **Do NOT use tweezers** in order to avoid damaging screw thread;
- each part needs thorough washing with warm water and detergent, and rinsing with cold water. Use tube-brush provided to clean inside the labyrinth-tube [5] and the faucet [6]. Clean cream dispenser's [10] holes with a suitable brush.

*Note: It is advisable to leave parts soaking in the detergent solution for a few hours (i.e. when the machine is not been used) in order to dissolve all residues.*

- before reassembling parts lubricate gaskets with food compatible grease.

#### 4) Sanitising

- Prepare DISINFECTANT SOLUTION following the product instruction and pour in the container;
- turn on dispensing for as long as necessary. If required, let solution work for longer, turn off machine (to avoid using refrigerator needlessly);
- if necessary, rinse machine by operating with fresh water (following disinfection, do not handle any parts which will come into contact with food).

## 7 MAINTENANCE

### 7.1 Checking gaskets

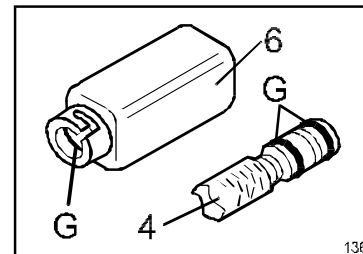
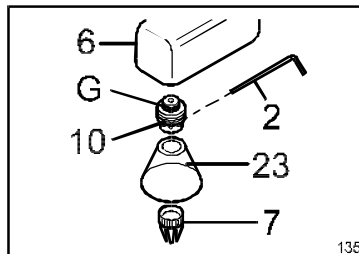
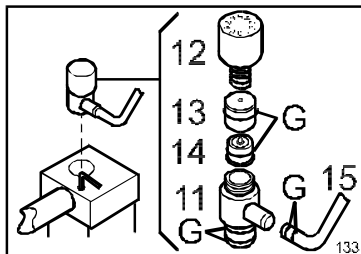

When dismantling parts for washing, regularly check that gaskets [G] are intact and replace them if damaged or dilated.

**Use only genuine gaskets, made of food-compatible rubber.** Our spare parts kit includes a complete set of Manufacturer approved gaskets.

It is necessary to replace all gaskets at least once a year. We advise to keep a spare set ready to use. Please refer to the Spares Ordering Section in the Technical Handbook.



#### Replacing gaskets correctly:

- remove old gaskets with a sharp tool, possibly a non-metallic one, taking care not to scratch the seatings;
- lubricate new gaskets with food compatible grease and fit them on.

### 7.2 Yearly maintenance

Periodically (according to environmental conditions) and in any case at least once a year, have the authorized Assistance Service or any qualified personnel carry out the following:

- general inspection of machine and its operations;
- accurate inspection of the pump's parts;
- **ABSOLUTE replacement of the pump rotor's sealing ring;**
- cleaning of air condenser.

### 7.3 Warnings for the service engineer

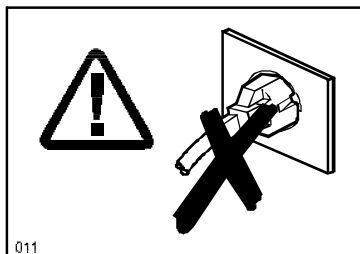

**ALL OPERATIONS ON CIRCUITS OR ON INTERNAL COMPONENTS OF THE MACHINE, FOR WHICH IT IS NECESSARY TO TAKE AWAY THE LATERAL PROTECTIVE PANELS, MUST BE MADE WHILE THE MACHINE ITSELF IS SHUT DOWN, AND ONLY AFTER UNPLUGGING IT.**



**BEFORE TURNING ON THE MACHINE, ALL LIMBS AND ANY OTHER KIND OF TOOL MUST BE REMOVED FROM COMPONENTS SUBJECT TO MOVEMENT AND ELEMENTS THAT COULD BE IN TENSION.**

---

## 8 PERIODS OF INACTIVITY

If long periods of inactivity are foreseen, proceed as follows:

- wash up accurately the machine (see par. 6.2);
- switch off the socket's power breaker and unplug the machine.

---

## 9 MALFUNCTIONS



**WE RECOMMEND YOU TO CALL IMMEDIATELY THE ASSISTANCE SERVICE IF A MALFUNCTION DIFFERENT FROM THOSE HERE DESCRIBED IS FOUND.**

---

---

### The machine does not seem to be working at all.

---

#### POWER indicator does not light.

Cause: The plug is not correctly plugged.

Cause: The socket is defective. A qualified technician should substitute it.

Cause: One of the circuit safety fuses is blown. Eliminate the cause for the overload and replace fuses.

Cause: Power in the socket is missing. Check that the power breakers and the safety breakers on the electric plant are closed. If they aren't, before closing them, make sure that no one is making electrical maintenance.

Cause: The supply cable is defective. Call the Assistance Service

Cause: Control electronic is damaged. Call the Assistance Service.

---

#### POWER indicator lights but machine does not turn on.

Cause: The machine or control electronic are damaged. Call the Assistance Service.

---

### When the machine is turned on or cream is dispensed the machine itself causes the electrical protections to switch off or the blowing of fuses.

Cause: The machine is damaged. Call the Assistance Service.

---

#### Cream comes out wet or flabby.

Cause: The air-inlet valve is too tight. Increase the opening by rotating the hand-grip on a higher number.

Cause: Cream has a high sugar content or a low quantity of fats. Choose another kind of cream.  
The cream is not suitable with the labyrinth. Call the Assistance Service.

Cause: Preservation temperature is too high. Call Assistance Service to adjust it.

Cause: The refrigerating plant is damaged. Call the Assistance Service.

---

#### Cream comes out liquid from the outlet nozzle.



**Cause: The air-inlet valve is obstructed. Disassemble and clean it as described in Section 6.**

---

---

**No cream dispensing (possible development of foam in the container). The pump's motor seems to be working.**

---



**Cause: Development of butter on the labyrinth and/or in the cream dispenser. Disassemble and wash them.**

---

Cause: Cream type is not suitable to the labyrinth (percentage of fats too high). Try diluting cream with milk or water. In case of difficulty, call the Assistance Service.

---

Cause: The intake tube is obstructed, disassemble and wash it.

---

Cause: Air infiltrations in the cream's pipe. Check that the parts are correctly assembled and the condition of O-rings, in particular on the intake tube.

---

Cause: The pump is damaged. Call the Assistance Service.

---

---

**Tendency at squirting cream.**

---

Cause: Air-inlet valve is excessively opened. Reduce it by rotating it on a lower number.

---

---

**Insufficient or lacking refrigeration.**

---

---

**Panels or ventilation loopholes are obstructed.**

---

Cause: Overheating due to lack of ventilation. Clean the loopholes, check the correct space around the machine for a normal ventilation and eventually wait 20 minutes.

---

---

**Ventilation loopholes are free, space for air circulation around the machine is sufficient, and the free space in front of the air condenser is correct (min. 20 cm).**

---

Cause: Refrigerating system had been subjected to repeated ignitions (REFRAIN FROM CARRYING OUT THIS OPERATION!) and compressor thermic protection automatically switched compressor off. Turn machine off by means of ON-OFF  Pushbutton, wait 5...10 minutes and turn on again.

---

*Note: Read Display and check that tub is correctly cooling down: do not only check the buzzing sound because this comes from FAN and not from compressor.*

---

Cause: Preservation temperature is too high. Call Assistance Service to adjust it.

---

Cause: The condenser is dirty. Call the Assistance Service.

---

Cause: The refrigerating system is damaged. Call the Assistance Service.

---

---

**Dispensing does not activate or abruptly interrupts (the pump motor seems stopped) without switching off the electrical protections or blowing the fuses.**

---

---

**A prolonged dispensing has just been made (5 minutes and over).**

---

Cause: Overheating of the pump motor due to overusage. The thermal protector has shut down the motor. Wait about 20 minutes.

---

---

**The motor has been correctly operated only for brief dispensings.**

---

Cause: An electrical failure has occurred, the pump motor is damaged, or the pump itself is exposed to a mechanical overload. Call the Assistance Service.

---

---

**Alarm code “AE” or “PE” appear on Display**

---

*Note: Alarm signals are unusual but possible under special circumstances. Before deciding that machine is out of order, switch machine off for as long as it takes to normalize temperatures (10...20 minutes), turn back on and check for alarm signals.*

---

**Alarm code “AE”: tub temperature is outside safety limits.**

---

Cause: The cream in the tub is too cold or, during washing, too hot liquids were used. Only use liquids with a temperature between +2 and +40°C.

---

Cause: Refrigerating system operated “empty” (cream container is empty or not in the tub). Do not allow this to happen for long periods of time.

---

Cause: Tub’s temperature probe is not working (open or out of range). Call Assistance Service.

---

**Alarm code “PE”: short circuit in tub’s temperature probe.**

---

Cause: Tub’s temperature probe is not working (due to a short circuit) or wiring is damaged. Call Assistance Service.

---

**Code “HC” appear on Display**

---

Cause: Refrigerating system is off. Call Assistance Service to adjust preservation temperature.

---

**Cream and/or water loss under the machine.**

---

Cause: The sealing ring of the pump’s rotor is worn. Call the Assistance Service for replacement.

---

**Unusual noises.**

---

Cause: The machine is damaged. Call the Assistance Service.

---



COSTRUTTORE:  
CONSTRUCTEUR:  
CONSTRUCTOR:



MANUFACTURER:  
HERSTELLER:  
FABRIKANT:

**TELME S.p.A.**  
**Via S. Pertini, 10 - 26845 CODOGNO (LODI) ITALIA**  
**Tel. 0377 / 466650 - Fax 0377 / 466690**

**Internet: [www.telme.it](http://www.telme.it)**

**E-mail: [telme@telme.it](mailto:telme@telme.it)**

Servizio Assistenza:  
Service d'Assistance:  
Servicio Asistencia:

Technical Service:  
Kundendienst:  
Servicedienst: